



## A Voltage-to-Frequency Converter for Greater Flexibility in Data Handling

ONE of the most flexible instruments presently available to the engineer is the electronic counter. Not only does the counter have an accuracy and a resolution that are matched by few instruments or techniques, but its speed of measurement, too, is relatively high, several measurements a second often being possible. For data-handling applications these qualities are attractive and are made even more attractive by the fact that many output coupling devices are currently available to enable the counter to transfer its data to such devices as electric typewriters, tape perforators, card punch machines, printers, and electronic computers.

SEE ALSO:  
-hp-'s division for special instrumentation, page 3

by few instruments or techniques, but its speed of measurement, too, is relatively high, several measurements a second often being possible.

The electronic counter can now be used to sample, measure, and handle data with considerably more flexibility than previously by the voltage-to-frequency converter shown in Fig. 1. This instrument converts dc or varying dc voltages to a proportional frequency which can then be measured by a counter to yield a direct indication of voltage. In other words, the converter-counter combination forms a fast and accurate digital voltmeter. Besides the fact that it operates with a general-purpose measuring instrument (i.e., a frequency counter), the converter has the advantage that it has low susceptibility to error from noise in the signal. Probably of even more importance, the converter-counter combination can integrate, aver-

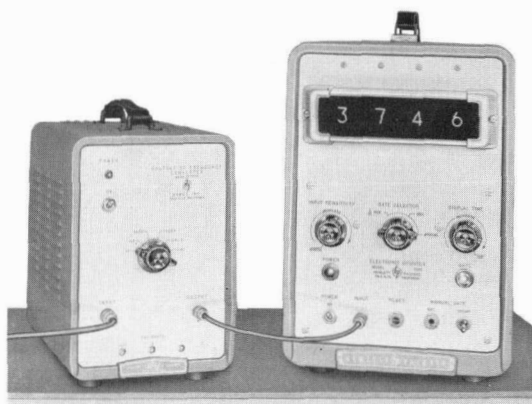

Fig. 1. Voltage-to-frequency converter (left above) simplifies data-handling problems by converting dc voltages to a proportional frequency which can be measured by a standard electronic counter. Many devices can then be used to enable counter to transfer its data to printers, tape, computers, etc. Converter is produced by Dymec, -hp-'s special-instrumentation division.

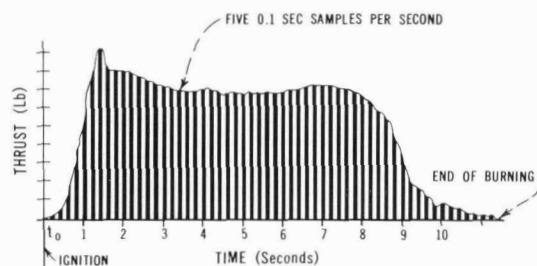

Fig. 2. Above time-plot of rocket thrust typifies data-measuring and logging abilities of equipment in Fig. 1 when used with digital printer (see Fig. 3). Equipment arrangement is simple, fast, and has low susceptibility to noise.

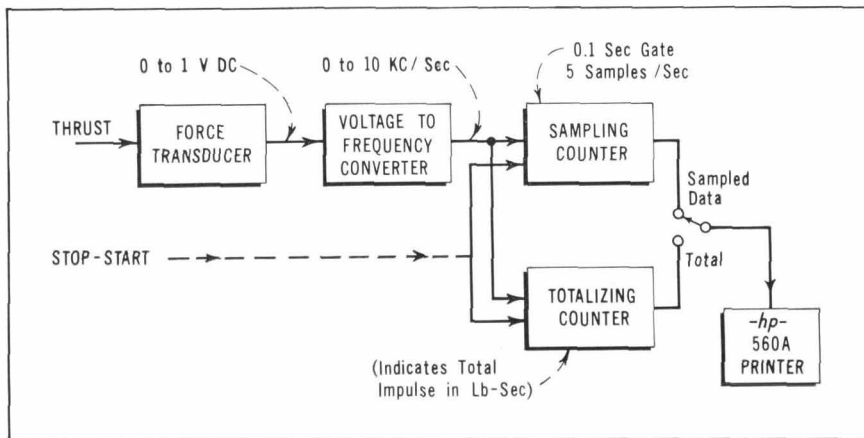

Fig. 3. Equipment arrangement used to log rocket-thrust data plotted in Fig. 2. Besides measuring and logging samples at rate of several per second, equipment also totalizes overall measurement.

age, and totalize the data, operations not directly possible with other common arrangements.

#### ROCKET THRUST MEASUREMENTS

A typical data-logging situation wherein the converter's characteristics prove advantageous occurs in the rocket-thrust measuring setup indicated in Fig. 3. Here the thrust developed by the rocket during firing is caused by a simple transducer to produce a proportional dc voltage. When this dc is applied to the converter, the converter in turn produces pulses at a rate proportional to the applied voltage. The converter's proportionality factor is 10 kc\* per volt, thus giving the arrangement a high resolution such that changes in the applied voltage as small as one-tenth millivolt can readily be measured by the counter. An input attenuator on the converter permits dc voltages as large as 1,000 vdc to be accommodated in four decade ranges. When the attenuator is used, the proportionality factor becomes 10 kc per full scale voltage value of the range used.

Two types of information can be directly provided by the setup in Fig. 3. First, the time-plot of the rocket thrust as in Fig. 2 is obtained by operating one counter with a 0.10 second gate time. Using this gate

time, five measurements and five readouts per second are made of the rocket thrust. When the counter is operated with a digital printer, these data are sequentially printed on a paper tape and can then be used to plot the thrust as in Fig. 2. Using the converter-counter combination in this way has the advantage that each measurement is averaged over a 1/10-second interval. Noise that may accompany the dc signal is thus averaged out of the measurement to a large extent, whereas measurements made on the basis of instantaneous comparisons are subject to large errors from noise.

#### INTEGRATED MEASUREMENTS

At the same time that the data are being sampled by the first counter, a second counter can be used to integrate the total measurement, thus providing a second type of information. If the counter gate is opened at the instant of rocket ignition and kept open for the duration of the test, the counter will totalize the converter output pulses, thereby providing the total area under the thrust-time curve. This total in pound-seconds constitutes the total impulse of the rocket.

#### DATA LOGGING ON TAPE OR TYPEWRITER

A general arrangement in which the converter enables data to be

logged either on an electric typewriter or a punched tape is shown in Fig. 4. The converter-counter combination operates as before to produce a pulse train whose repetition rate is proportional to the applied dc analog signal. The scanner/coupler accepts a coded signal produced by the counter and drives either a typewriter or tape punch as desired. If desired, multiple analog signals can be accommodated by this system by using a scanner at the input to the converter. The scanner can be programmed to measure the inputs in any desired sequence.

This simple logging system will readily give four-digit or five-digit resolution and a measurement accuracy exceeding 0.1% by selecting the appropriate combination of converter and counter.

#### INTEGRATING-CIRCUIT CONVERSION TECHNIQUE

The advantage that the converter achieves with regard to a low sensitivity to noise occurs through use of the circuit arrangement indicated

(Continued on page 4)

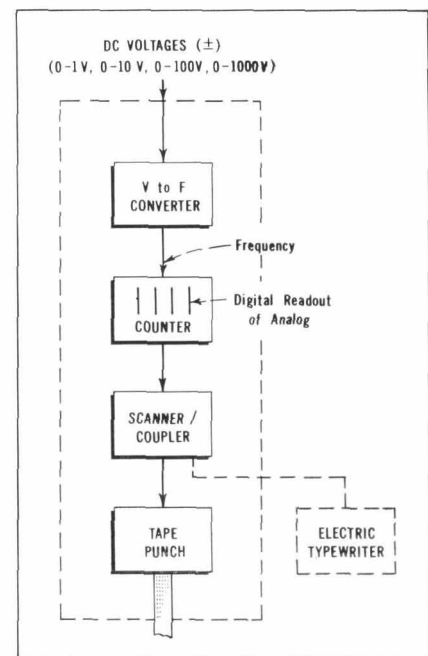

Fig. 4. Converter and counter combination can be used to measure and record data on punched tape or electric typewriter. Four- or five-digit resolution can be obtained at an accuracy of better than 0.1%.

\*100 kc per volt is also obtainable in a companion instrument; see specification table.

## DYMEC — AN *-hp-* SERVICE FOR SPECIAL INSTRUMENTATION SITUATIONS

Need a system for automatic testing?—for data logging?—for production-checking of radar performance?—or for ground support of airborne or missile electronics? Perhaps the need for a special-purpose instrument for some unusual measuring problem is slowing your operation.

Dymec, the *-hp-* division that produces the voltage-to-frequency converter described in the accompanying article, was established by *-hp-* to be of service in just such situations as the above. Dymec's specific function is to serve as a knowledgeable, dependable source of specialized instrumentation available to those faced with special measurement requirements. It is a source that can provide special-purpose instrumentation on a rapid and efficient basis.

Dymec's special-purpose services cover a wide span in the electronics

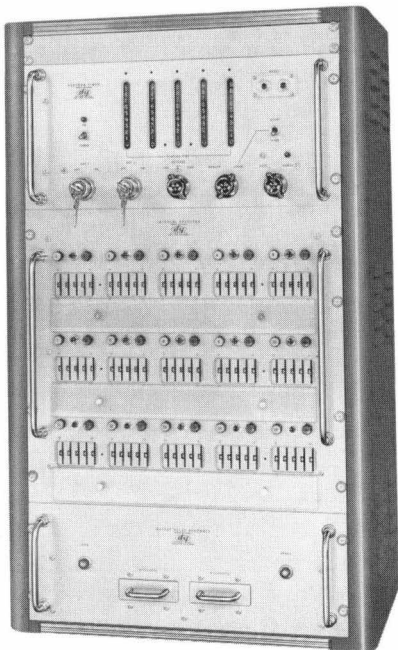

*Typical of special instrumentation produced by *-hp-*'s Dymec division is above program timing system. System will start and/or stop 15 external functions in a programmable sequence by contact closures. System used for such purposes as controlling critical phases of missile test runs and firings. Accuracy is derived from internal crystal time base.*

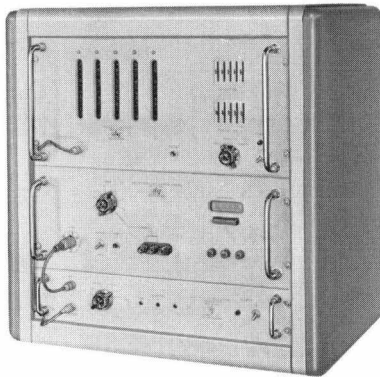

*Dymec go-no go measuring set measures and compares dc voltages against preset limits, then provides go-no go output signals. System also makes results available for recording by digital recorder. Measurement accuracy is  $\pm 0.1\%$ .*

field. *-dy-* provides, for example, several types of complete systems, one of the *-dy-* specialties being digital data systems. The digital systems can include a variety of arrangements for accepting data in analog or digital form and performing on it a number of types of measuring operations. These systems have read-out arrangements ranging from simple digital display to provision for operating supplementary equipment such as card punches, comparators, printers, computers and other peripheral equipment. To permit digital systems to be delivered at a reasonable cost and with a minimum time lapse, *-dy-* maintains a stock of special building-block modules that experience has shown to be most-often used in digital systems.

Besides supplying complete systems, *-dy-* provides individual specialized instruments that may be required for a particular system. The instrument may be one of a number of special-purpose instruments that Dymec has developed, a case in point being the voltage-to-frequency converter described in this issue; or it may be a signal generator having characteristics specifically adapted to check a particular receiver.

In the microwave field, Dymec's special simulators for testing doppler-shift radars are well known. *-dy-* also

produces automatic programmed signal generators for high-speed equipment test, as well as microwave test sets and systems components such as programmed attenuators, TWT modulators, BWO frequency controllers and power leveling devices.

To take advantage of this special-purpose instrumentation service, contact Dymec through your local *-hp-*/Dymec representative — or directly at

DYMEC, a division of  
Hewlett-Packard Co.  
395 Page Mill Road  
Palo Alto, California  
Phone: DAvenport 6-1755  
TWX PAL AL 117-U

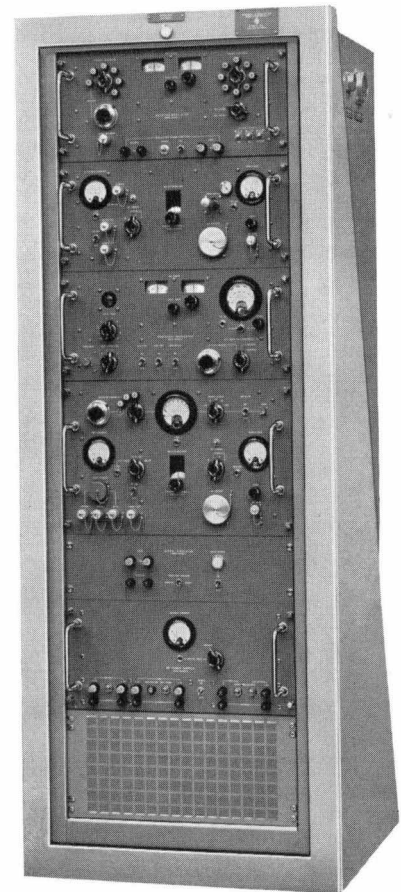

*Dymec signal simulator used for production tests of missile radar equipment.*

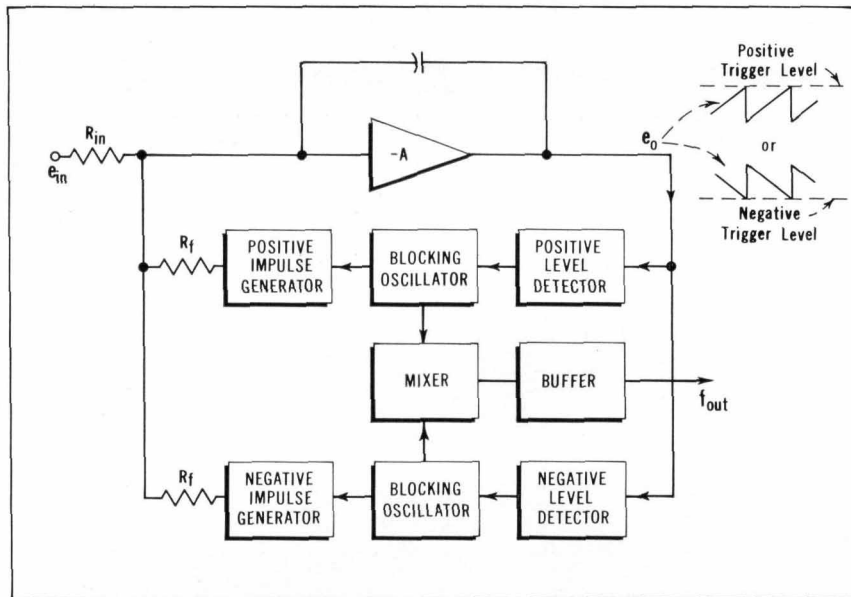

Fig. 5. Basic circuit arrangement of voltage-to-frequency converter. Circuit uses true analog integrator in generating output pulses whose frequency is proportional to integral of voltage being measured.

in Fig. 5. The heart of this circuit is a chopper-stabilized operational amplifier operating as an analog integrator. The integrator is provided with two additional feedback circuits which, when triggered, can generate pulses of opposite polarity, as indicated by the diagram.

When a dc voltage, either steady or varying and of either polarity, is now applied to the input terminals, it is integrated until the integrator output level reaches one of the trigger levels that activates the positive or negative level detector. When this occurs, the activated feedback circuit generates a pulse of fixed area and of a polarity opposite to the externally-applied dc. This pulse is applied to the integrator and is arranged to have an area in volt-seconds such that it is the proper amount to restore the integrator output level to a zero condition. When the integrator output is reduced or reset in this manner, a pulse is applied to the output terminals of the instrument. If the dc signal voltage continues to be applied, the integrator and feedback circuits repeat

the cycle, passing along to the output a series of pulses. The frequency of these pulses will be proportional to the magnitude of the voltage applied to the instrument, since larger applied voltages will cause the integrator to reach one of the detector levels proportionately sooner than smaller voltages. The pulses produced at the output of the instrument are all of the same polarity, however, regardless of the polarity of the input. Output pulse detail is indicated in Fig. 8.

The foregoing mechanism of subtracting the integral of the constant-area feedback pulses from the integrated input voltage being measured results in a piece-wise but true analog integrator. Thus, over any definite period of time, the number of feedback pulses generated is proportional to the integral of the voltage being measured. When this integrated value is divided by the period of integration (determined by the gating of the counter), the result is the average value of the voltage being measured. The combination of the converter and counter therefore

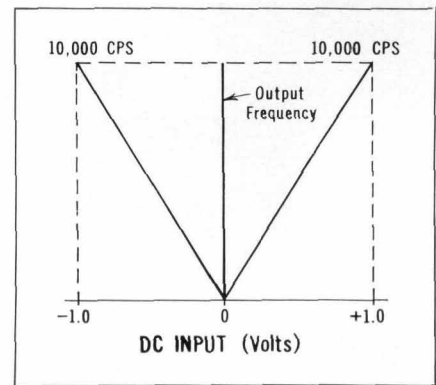

Fig. 6. Input voltage-output frequency characteristic of basic Dymec voltage-to-frequency converter. Models producing 100 kc full scale are also available.

forms an average-reading dc digital voltmeter which is direct-reading in voltage because of the conversion ratio and standard gate times used.

Physically, it can be seen that the converter tends to average out the effect of most types of noise that may accompany the signal. Even though noise may position-modulate one or more pulses in one direction in time, the next pulse or pulses are likely to be displaced a corresponding amount in a compensating direction. When the frequency of this pulse train is then averaged over an interval by the gating action of the counter, the overall effect of noise is generally small and is significantly less than measurements that depend on single instantaneous comparisons.

The integrator uses a high-gain circuit to achieve high linearity with the result that overall linearity is primarily a function of the constancy of the area of the feedback impulses. This is such that the output of the converter is linear in frequency within  $\pm 0.002\%$ , i.e., at the full scale value of 10 kc deviation in the pulse train is not greater than one-fifth of a cycle per second.

#### ACCURACY

To enable the converter to be of maximum use in high-accuracy applications, a calibrated mercury cell\* is included together with a conven-

\*Oven-housed zener diodes are used in some models of the instrument.



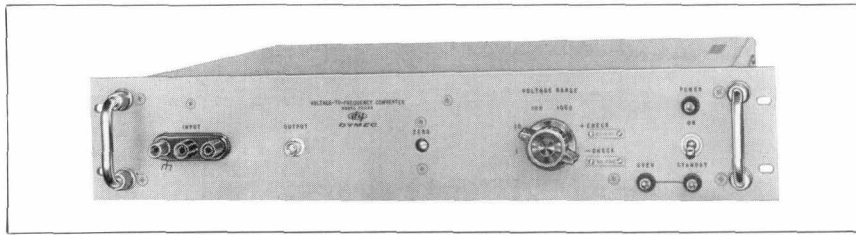

Fig. 7. 100 kc version of voltage-to-frequency converter in rack-mounting style.

ient panel switching arrangement that connects the cell in either polarity to the converter input. The proper output frequency corresponding to this cell is indicated on the panel and the output frequency can be adjusted from the panel for optimum agreement for both positive and negative polarities. If higher accuracy is desired, the converter can be calibrated against an external dc standard.

In other respects the characteristics of the instrument are such that accuracies of within  $\pm 0.06\%$  are typical after the unit has been cali-

additional small tolerance should be allowed for the input attenuator, as indicated in the instrument specifications.

#### RESPONSE TO VARYING VOLTAGES

One of the additional advantages that this type of converter offers is that its response is considerably faster than the analog signals ordinarily encountered when investigating mechanical quantities. If the signal applied to the converter changes in magnitude, for example, the converter will begin producing pulses of the corresponding new frequency within a fraction of a millisecond to a few milliseconds. This is demonstrated in the oscillogram of Fig. 9 which shows typical converter performance for the extreme case of a step change in input voltage. The upper trace shows the input voltage, while the lower trace shows the corresponding output from the instrument. For a change in level that does not involve a change in polarity (the usual case), the instrument produces the proper new frequency in a maximum of one period of the new frequency. If the step change does not occur immediately after the integrator is reset, the change to the new frequency occurs even faster. Fig. 9 shows the case for a change from a lesser to a greater voltage, but the waveforms can be considered to apply for a step in the opposite direction if time is considered to increase toward the left instead of the right. An important consideration here is that the integral, or average, is accurately represented by a count of output pulses even though step changes (without polarity reversal) occur in the input during the count-

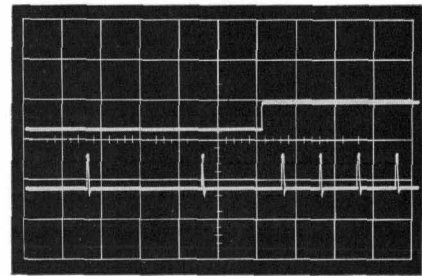

Fig. 9. Oscillogram illustrating how converter output frequency responds to a fast input voltage change from one level to another at same polarity. Converter produces new pulse of proper rate within one period of new frequency. Because of averaging effect of converter and counter, the counted output pulses accurately include a fast change in input such as this.

ing period. This is tantamount to saying that the pulse rate changes instantaneously with input, which it does. A change in steady-state frequency can not be recognized, however, until pulses of the new proper frequency are actually generated.

In some cases such as when using balanced strain gage transducers the signal may change in polarity. Where such a change occurs, the response time of the converter may be several times as long as for a change that involves no polarity change. The worst-case response time in this case is given by

$$T = \frac{1 \times 10^{-3}}{e_{in}} \text{ seconds,}$$

where  $e_{in}$  is the new voltage level of the new polarity. Thus, if such a change occurred in the form of a step to the opposite full-scale value, the worst-case response time would be faster than if the input changed to only a fraction of the opposite full-scale value. This effect occurs because of integration considerations, but from a usage point-of-view it is more informative to consider how many output pulses may be lost during such a transition. If the above expression is worked out for the number of counts that occur during the response time, the answer is found to be always 10.\* In other words no more than 10 output pulses of the proper new pulse frequency

\*The number 10 also applies to the 100 kc version.

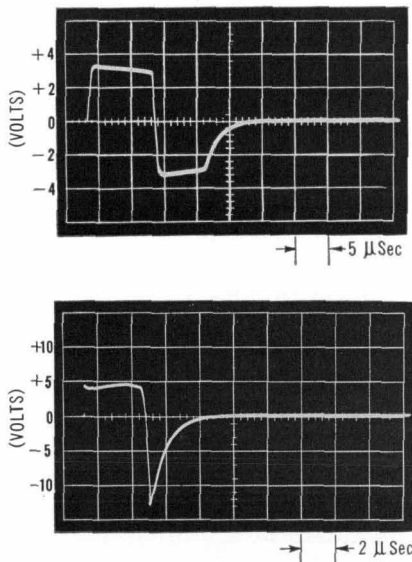

Fig. 8. Detail of output pulses provided by Model 2210 (upper) and Model 2211 (lower) voltage-to-frequency converters.

brated. This allows for such factors as operating the instrument up to  $\pm 10\%$  from center-value line voltage, for day-long instrument stability, and for  $\pm 5^\circ\text{C}$  ambient temperature variations. If ranges other than the 1-volt range are used after the instrument has been calibrated, an

would be lost if the input voltage changes polarity. In most cases this would constitute only a slight error, but for a new voltage of small percentage of full scale the error could be significant. In such a case it might be desirable to arrange to bias the input voltage or to take other external measures to avoid this condition.

#### OTHER MODELS AND VARIATIONS

The above discussion has described the general nature of the converter, but it should be noted that several models of the converter have been designed, as indicated in the table of specifications. The various models are distinguished by such factors as different full-scale frequencies, floating or grounded input systems, internal voltage standardization by oven-controlled zener diodes or mercury cells, different accuracy ratings, etc.

In addition to the differences in models, the individual models have several optional variations that fit the converters to various specific applications. To enable one of the converters (Model 2210) to be especially suited to recording its output on magnetic tape, for example, an optional output system is available that provides a special square wave output at half the converter's normal frequency.

Other optional arrangements include special full-scale frequencies, special voltage ranges, output signals for indicating the polarity of the applied voltage, etc. These options are indicated in the instrument specification table.

#### ACKNOWLEDGMENT

The technique on which the voltage-to-frequency converter is based is due to Mr. A. Frank Boff of the Hewlett-Packard Company who conceived and first reduced the technique to practice.

—R. A. Andersen

## SPECIFICATIONS

### DYMEC MODEL 2210 VOLTAGE-TO-FREQUENCY CONVERTER

**INPUT:**  
Voltage ranges: 0 to 1 volt dc, 0 to 10 volts dc, 0 to 100 volts dc, 0 to 1000 volts dc. (Other ranges on special order.)  
Polarity: Sensitive to positive and negative inputs.  
Impedance: 1 megohm shunted by 200  $\mu\text{f}$ , all ranges.  
Connector: BNC.  
**OUTPUT:**  
Frequency: 0 to 10,000 cps (nominal full scale). (Output responds to input overload of 30%, all ranges except 1000v.)  
Accuracy: (a) Basic Instrument  
Accuracy within  $\pm 0.06\%$  of full scale can be expected under typical working conditions. (Conditions: Calibration once per day. Max effects of 24-hour zero drift,  $\pm 10\%$  line voltage change,  $\pm 5^\circ\text{C}$  temperature change, non-linearity, added in rms fashion.)  
Stability (at constant line voltage and temperature)  $\pm 0.03\%$  of full scale per day.  
Line Voltage Effect: less than  $\pm 0.02\%$  of full scale for  $\pm 10\%$  line voltage change.  
Linearity:  $\pm 0.002\%$  of full scale.  
Temperature Coefficient:  $\pm 0.01\%$  of reading per  $^\circ\text{C}$  (20 to  $40^\circ\text{C}$ ),  $\pm 0.02\%$  of reading per  $^\circ\text{C}$  (10 to  $50^\circ\text{C}$ ).  
Accuracy: (b) Attenuator.  
Max. possible division error at  $25^\circ\text{C}$   $\pm 0.05\%$ .  
Temperature coefficient  $\pm 0.006\%/^\circ\text{C}$ , 10 to  $50^\circ\text{C}$ . Additional max. possible error on 1000v range with 1000v applied to input  $\pm 0.067\%$ .  
Impedance: 3,000 ohms.  
Waveshape: Output pulse is capacity coupled from an emitter follower.  
Connector: BNC.  
Self-Check: Against internal mercury cell or external voltage standard.  
Power Requirements: 115v  $\pm 10\%$ , 60 cps, 40 watts (for 50 cps to 400 cps operation see Option 5).  
Dimensions: Cabinet Model: 9 $\frac{7}{8}$ " high x 7 $\frac{3}{8}$ " wide x 11 $\frac{1}{16}$ " deep. Rack Model: 3 $\frac{15}{16}$ " high x 19" wide x 10 $\frac{3}{16}$ " deep behind panel.  
Weight: Cabinet Model: net weight 13 lbs., shipping weight 19 lbs. Rack Mounting: net weight 13 lbs., shipping weight 18 lbs.  
Price: Cabinet model \$660; rack-mounting model \$650. Includes 4'-long BNC-terminated, coaxial input cable (P/N 3170-0007).

#### OPTIONS

- 1. Square-Wave Output**  
A square-wave output at one-half the pulse frequency is brought out to a BNC connector on the rear panel. This option can be used, for example, to record the output on magnetic tape. The standard pulse output at the front panel BNC is retained. Add \$85.
- 2. Input Polarity Indication**  
Two neon indicators are provided on the front panel, indicating positive and negative polarity of input, respectively. In addition a control signal, suitable for operation of a Hewlett-Packard 560A Digital Recorder, is brought out to a BNC connector on the rear panel. Add \$85.
- 3. Duplicate Rear Connectors**  
Duplicate BNC connectors for INPUT and OUTPUT are mounted on the rear panel. These are wired in parallel with the respective front panel connectors. Add \$15.
- 4. Separate Outputs**  
Two OUTPUT BNC connectors are provided on the rear panel, supplying individual outputs for positive and negative inputs. The standard combined pulse output at the front panel BNC is retained. Add \$50.
- 5. Operation from 50-400 cps Supplies**  
Instrument will operate from supply line frequencies of 50/60 cps or 400 cps (state which when ordering). Add \$50.

### DYMEC MODELS 2211A/B VOLTAGE-TO-FREQUENCY CONVERTERS

**INPUT (FLOATING):**  
Converter may be operated at potentials up to  $\pm 250$  vdc with respect to chassis ground.  
Voltage Range: 0 to 1 vdc. Other ranges on special order. See also Option 6.  
Polarity: Sensitive to positive and negative inputs.  
Impedance: 1 megohm shunted by 200  $\mu\text{f}$ .  
Connector: Binding posts ( $\frac{3}{4}$ -inch centers): High, Low, and Chassis Ground.  
**OUTPUT:**  
Frequency: 2211A, 0 to 10,000 cps; 2211B, 0 to 100,000 cps. (Output of 2211A and B responds to input overload of 20%.)  
Accuracy: Accuracy within  $\pm 0.02\%$  of full scale can be expected from the 2211A under typical working conditions. For the 2211B a figure of  $\pm 0.03\%$  is typical.  
(Conditions: Calibration once per day. Max. effects of 24-hour zero drift,  $\pm 10\%$  line voltage change,  $\pm 5^\circ\text{C}$  temperature change, non-linearity, added in rms fashion.)  
Stability (at constant line voltage and temperature)  $\pm 0.02\%$  of full scale per day.  
Line voltage effect: less than  $\pm 0.006\%$  of full scale for  $\pm 10\%$  line voltage change.  
Linearity: 2211A  $\pm 0.002\%$  of full scale, 2211B  $\pm 0.002\%$  of full scale,  $\pm 0.01\%$  of reading.  
Temperature coefficient:  $\pm 0.001\%$  of reading per  $^\circ\text{C}$  (10 to  $50^\circ\text{C}$ ).  
Output Waveform: Output pulse is transformer coupled from a blocking oscillator.  
Output Impedance: Positive pulse virtually unaffected from no load to 500 ohm load. Negative spike decreases from 10v at no load to 4v at 500 ohm load. Load impedances less than 500 ohms progressively deteriorate the output waveform.  
Connector: BNC.  
Self-Check: Against internal zener diodes (0.1% accuracy).  
Power Requirement: 115/230v  $\pm 10\%$ , 60 cps, 120 watts.  
Dimensions: (Rack model) 3 $\frac{15}{16}$ " high x 19" wide x 18" deep behind panel.  
Weight: Net wt. 26 lbs., shipping wt. 40 lbs. approx.  
Accessories Supplied: Coaxial input cable, BNC-terminated, 4 feet long (part no. 3170-0007).  
Price: Voltage-to-Frequency Converter, rack-mount, model 2211A or 2211B: \$1,250.

#### OPTIONS

- 1. Not applicable.**
- 2. Input Polarity Indication**  
Two neon indicators are provided on the front panel, indicating positive and negative polarity of input, respectively. In addition, a single-pole double-throw relay contact closure is brought out to a rear MS3102A-10SL-3P connector. Add \$150.
- 3. Duplicate Rear Connectors**  
An INPUT connector type UA-3-32 and an OUTPUT BNC are mounted on the rear panel; these are wired in parallel with the respective front panel connectors. The mating input connector type UA-3-11 is also supplied. Add \$25.
- 4. Individual Output Connectors**  
Two OUTPUT BNC connectors are provided on the rear panel, supplying individual outputs for positive and negative inputs. The standard combined pulse output at the front panel BNC is retained. Add \$75.
- 5. Operation from 50/60 cps Supplies**  
Instrument is modified to permit operation from supply line frequencies of 50 or 60 cps. Add \$50.
- 6. Input Attenuator**  
Input ranges 1, 10, 100, 1000v full scale. Max division error at  $25^\circ\text{C}$ ,  $\pm 0.05\%$ , Max temperature coefficient,  $\pm 0.0015\%$  per  $^\circ\text{C}$ . Add \$150.
- 7. Rack-Mounting Slides**  
Instrument is fitted with slides, permitting easy withdrawal from rack. Specify rack type and depth between front and rear mounting rails when ordering. Price on request.

Data subject to change without notice.  
All prices f.o.b. Palo Alto, California